

MR2800-W

56K MODEM RISER

User's Manual

Version 1.1

Contents



	Preface	4
Chapter 1	Introduction	5
Chapter 2	Before You Begin	6
	2.1 Minimum System Requirements	6
	2.2 Safety Precaution	6
	2.3 Installation Notes	7
Chapter 3	Setting Up Your Modem Card	8
	3.1 Configuring the Modem Card	8
	3.2 Installing the Modem Card	10
	3.3 Connecting the Modem Card	13
Chapter 4	Installing the Modem Driver	14
	4.1 For Windows® 95	14
	4.2 For Windows® 98	16
Chapter 5	Testing the Modem Card	19
	5.1 Windows® 95/98	19

Appendix A	Frequently Asked Questions	22
Appendix B	Technical Specifications	26
Appendix C	Card Layout	28

Preface

Product warranty does not apply to damage caused by lightning, power surges or wrong voltage usage.

This manual gives you a step-by-step guide of the following:

1. Configuring the modem card
2. Installing the modem card
2. Connecting the phone line for Internet
3. Installing the modem drivers required to run the modem
4. Testing the modem

The section - *Frequently Asked Questions (FAQ)* will explain some of the technical terms used in this manual, as well as the possible solutions for some of the commonly asked questions by users.

For further technical details on your card, you may refer to the **ReadMe.txt** file found in your **MR2800-W Installation CD**.

Chapter 1



Introduction

Congratulations on your purchase of MR2800-W Modem!

With the 56K MR Modem alone, you can perform a comprehensive range of modem-related functions including data communications, sending and receiving of faxes.

The intensive demands of today's Internet applications will no longer be a bottleneck. Using the 56K MR Modem, you can now download graphic intensive web pages, high bandwidth audio and video files as well as large file size software programs at speeds of up to 56Kbps.



Chapter 2

Before You Begin

This chapter contains information that you need to know before installing your modem card. They are the basic system requirements needed for your modem card to run, the safety rules to follow, as well as the installation guidelines.

2.1 Minimum System Requirements

- IBM PC-based computer with Intel® Celeron™ 366MHz Socket 370 processor
- AMR Bus slot
- 32MB RAM
- 10MB hard disk space (system files and modem drivers only)
- CD-ROM drive
- Windows® 95/98 / NT®4.0

2.2 Safety Precaution

- Do not remove your card from its protective bag until you are ready to install it.
- Always try to hold your card by its edges. Avoid touching any electronic components on your card.
- Static electricity can cause permanent damage to your card. To prevent such a damage, you must ground yourself during the installation:

- » Use a grounding strap - a coiled wire with a clip at one end and an elastic strap at the other. Wear the strap around your wrist and attach the clip to any non-painted metal surface of your computer chassis.
- » If you do not have a grounding strap, touch any non-painted surface of your computer chassis before you begin installation, and again every minute or so until the installation is completed.

2.3 Installation Notes

- The graphics and screens illustrations shown in this easy start may differ from what you see in your system, but the steps still apply.
- A Philips screwdriver is required.
- The documentation for your computer should come in handy during the installation. Have it ready by your side.
- If you have an existing *non* Plug-and-Play modem installed in your computer, you must first un-install its modem driver before you remove the card. Refer to the documentation of your existing modem for details.

If your existing modem is Plug-and-Play, you may proceed to install your new modem.

Chapter 3

Setting Up Your Modem Card

This chapter contains information on how to configure, install and connect your modem card.

3.1 Configuring the Modem Card

Please carry out the following steps **BEFORE** installing your modem card.

MR2800-W modem needs to be configured as either *Primary* or *Secondary* device before you can proceed to install the card on your PC.

To determine the choice of configuration, you need to refer to the **BIOS Setup details on your Motherboard User's Manual**. Check for the **presence of AC'97 Audio**** setting in the BIOS Setup. (Note that not all motherboards will support AC'97 Audio).

- a) If **AC'97 Audio is present**, (that is you can see it in the BIOS Setup of your motherboard User's Manual), you may configure your card as either **Primary** or **Secondary** device.
 - i) If **AC'97 Audio is Enabled**, you must configure your card as a **Secondary** device.
 - ii) If **AC'97 Audio is Disabled**, you must configure your card as a **Primary** device.

(See the following page on - **Configuring as Primary/Secondary Device**)

- b) If **AC'97 Audio is not present** (that is you cannot see it in the BIOS Setup of your motherboard User's Manual), you must configure your card as **Primary** device. (See the following page on - **Configuring as Primary/Secondary Device**)

**your system may show *AC'97 Audio controller*



Some systems may have additional onboard audio chips. 'AC'97 Audio' and 'Onboard Audio' are two different options in the BIOS Setup. When system is using Onboard Audio, AC'97 Audio is disabled.

Configuring as Primary/Secondary Device

To configure as a *Primary* device:

On your card, insert the jumpers on **Pin 2 and 3** for **J1, J2 and J3**.

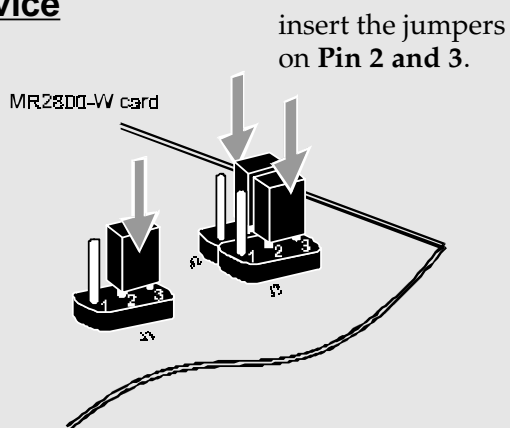

To configure as a *Secondary* device:

On your card, insert the jumpers on **Pin 1 and 2** for **J1, J2 and J3**.

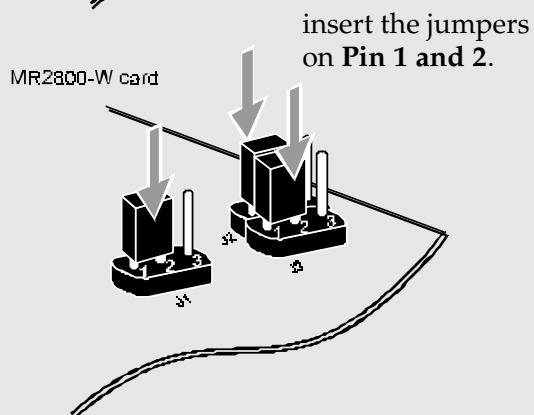

3.2 Installing the Modem Card



You need to remove any existing modem installed in your computer. If your modem is non Plug-and-Play, you need to un-install its modem driver before you remove it. Check your existing modem documentation for details on this.

Power off your computer and any connected devices before installing your modem!

- 1 Remove the cover of your computer.

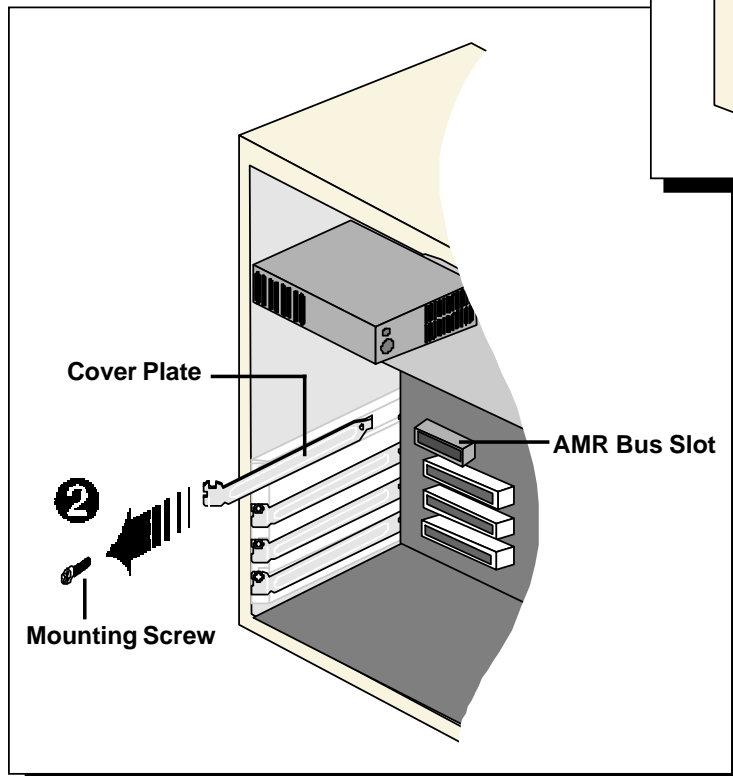
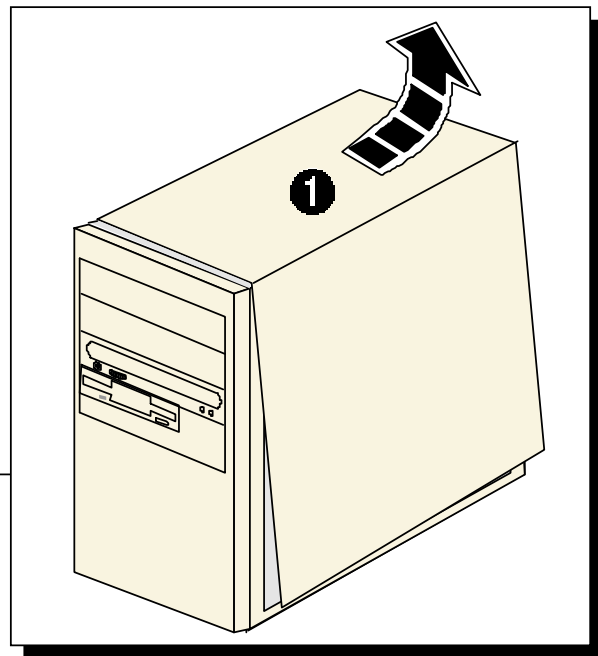

- 2 Locate the AMR Bus slot and remove its cover plate. Keep the mounting screw to secure your card later.

- 3 Align your card with the AMR Bus slot and firmly push it into the slot. If the card does not slide in, do not force it. Make sure that the card is lined up properly and try again.

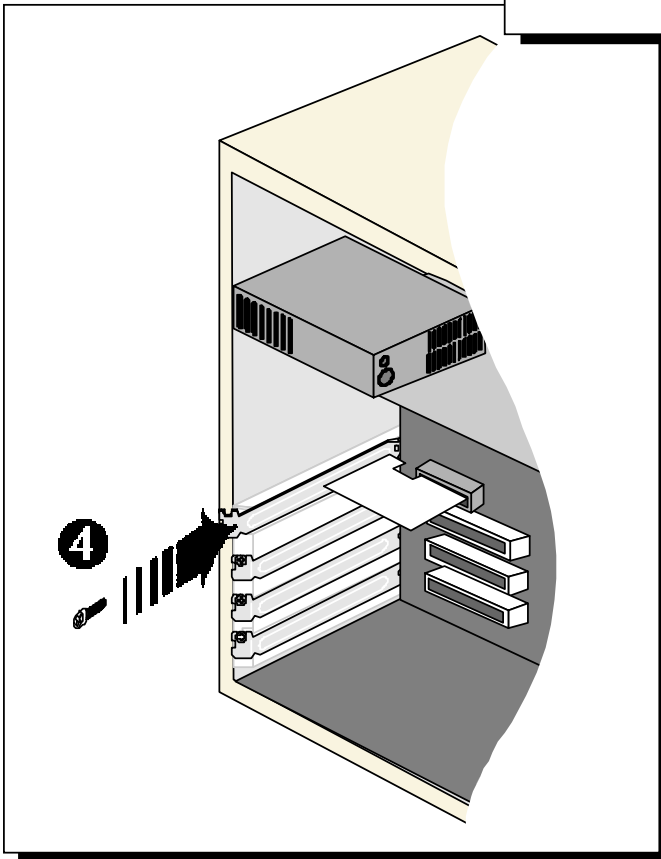
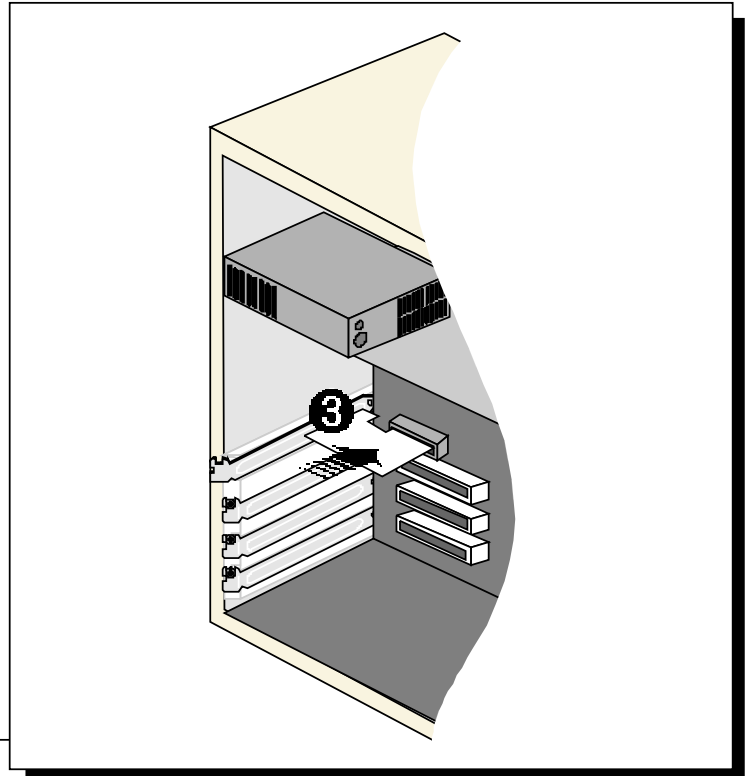

- 4 Secure your card to your computer chassis with the mounting screw.

- 5 Replace the cover of your computer.

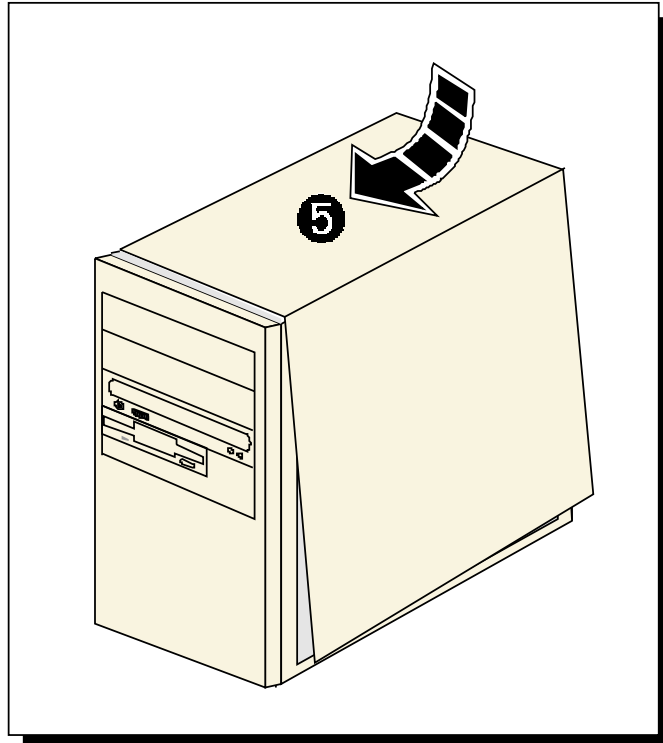

3.3 Connecting the Modem Card

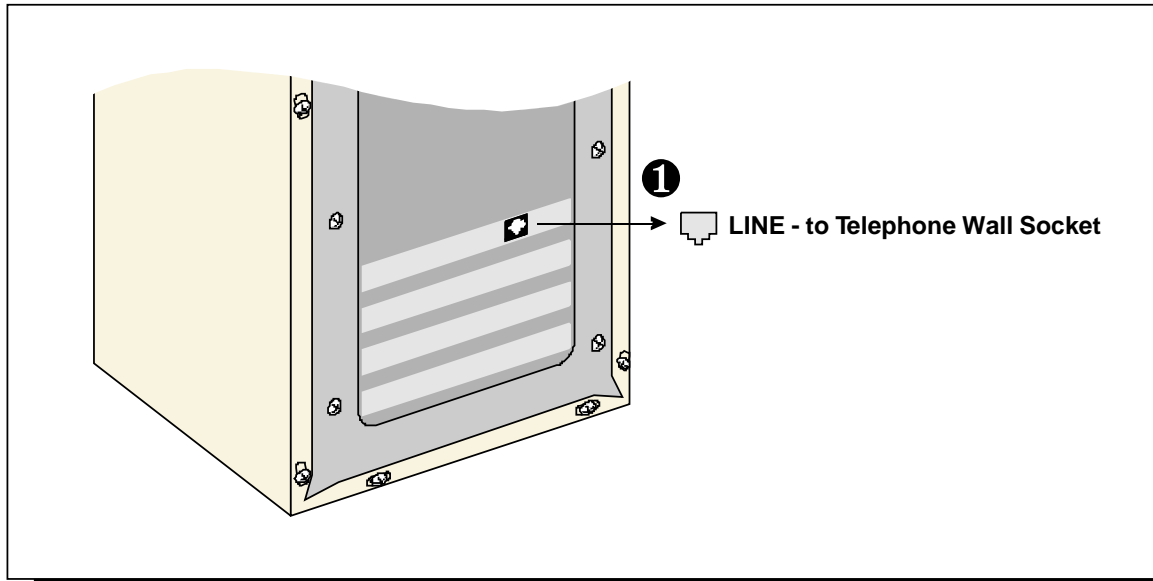

- 1 Connect one end of the **telephone extension cable** to the **modem card** and the other end to your **telephone wall socket**.

This completes the setting up of your modem. Please proceed to the next chapter to install your modem driver.

Chapter 4

Installing the Modem Driver

This chapter contains information on how to install the modem driver in Windows® 95 and Windows® 98.



The graphics and screens illustrations shown in this easy start may differ from what you see in your system, but the steps still apply!

If problems are encountered with connection or performance of this modem, please ensure that the country setting is correct for your location. In some cases, the country is set to match the Operating System selected and may need to be re-selected to match your exact location. For instructions on how to change the setting, refer to Appendix A - Frequently Asked Questions "I am using my system with the modem card in another country. Is there any settings that need to be changed ?".

4.1 For Windows® 95

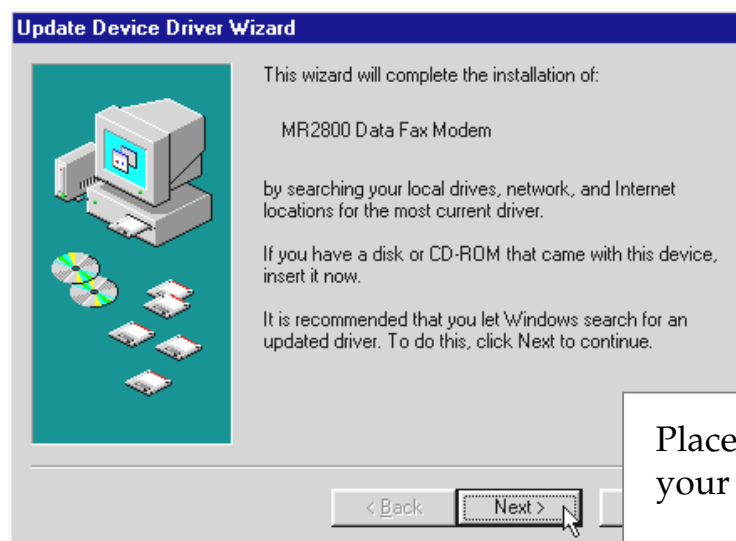

Power on your computer to start Windows® 95. Windows will detect the newly installed modem and an **Update Device Driver Wizard** window will appear.



Place your **Installation CD** into your CD-ROM drive.

Click **Next**.

Windows® 95 will now prompt you that the modem driver has been found.

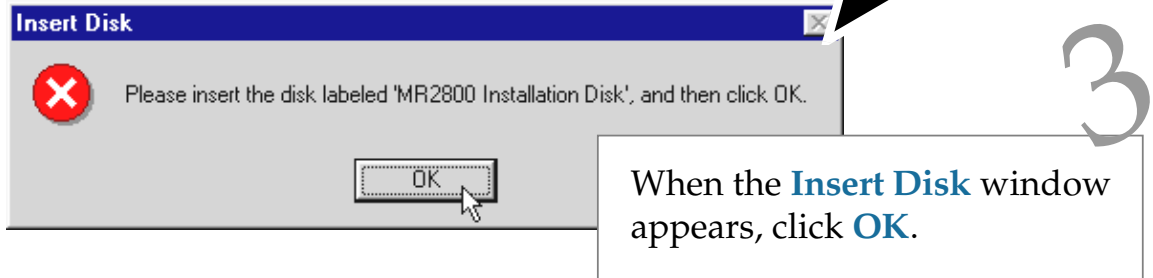
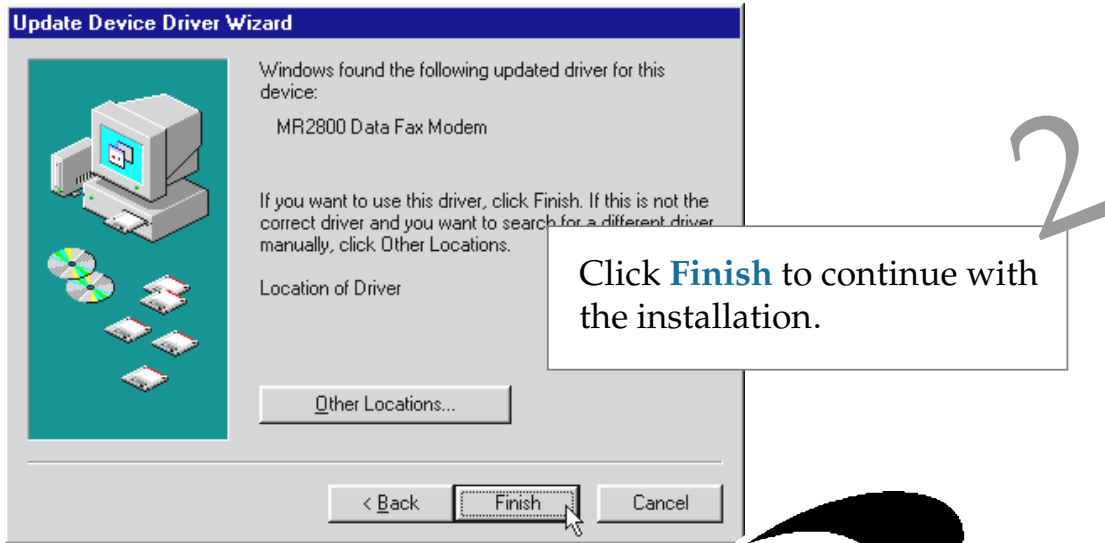

4 From the **Copying Files...** dialog box, type “D:\” in the text box and click **OK**.

(Assuming you have placed the Installation CD in your CD-ROM Drive D. Else substitute the drive letter accordingly.)

Follow the on-line instructions to complete the driver installation.

This completes the installation of the modem driver in Windows® 95. Proceed to the next chapter to test your modem.

4.2 For Windows® 98

Power on your computer to start Windows® 98. Windows® 98 will detect the newly-installed modem and an **Add New Hardware Wizard** window will appear.

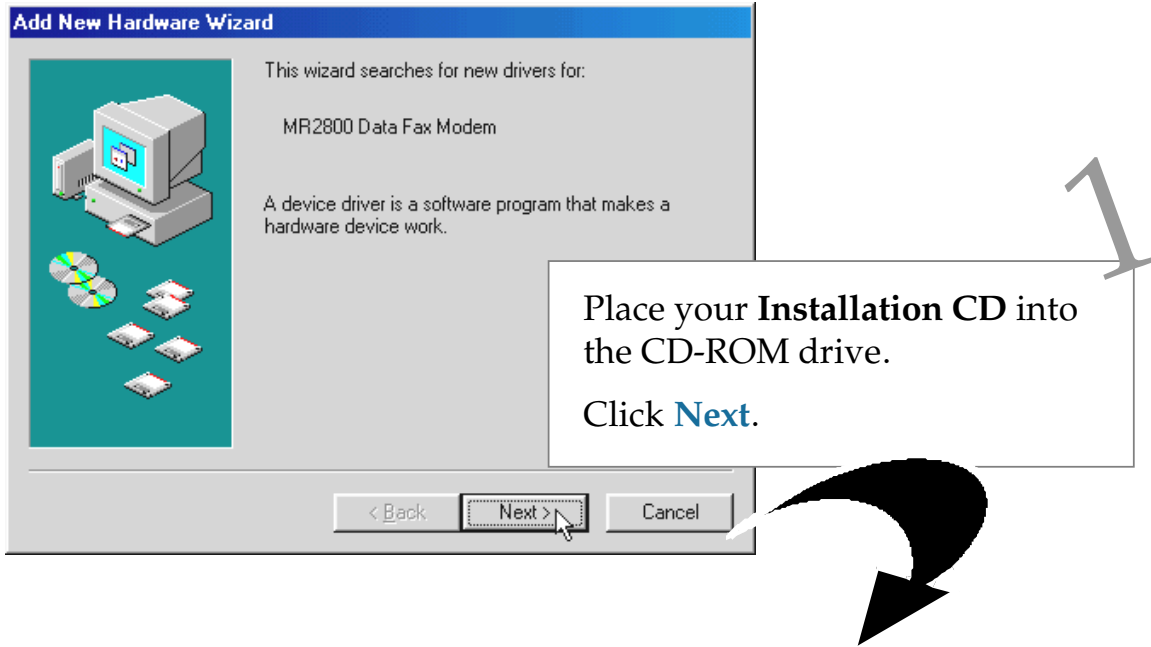

The next window prompt will ask for your modem driver.

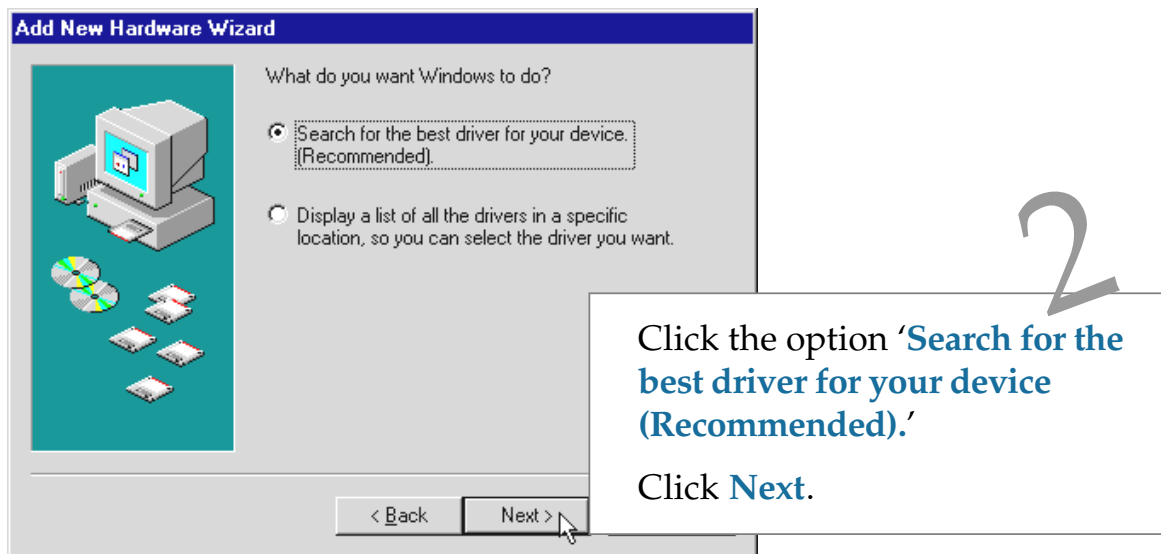

At the next prompt, select the source of your driver.

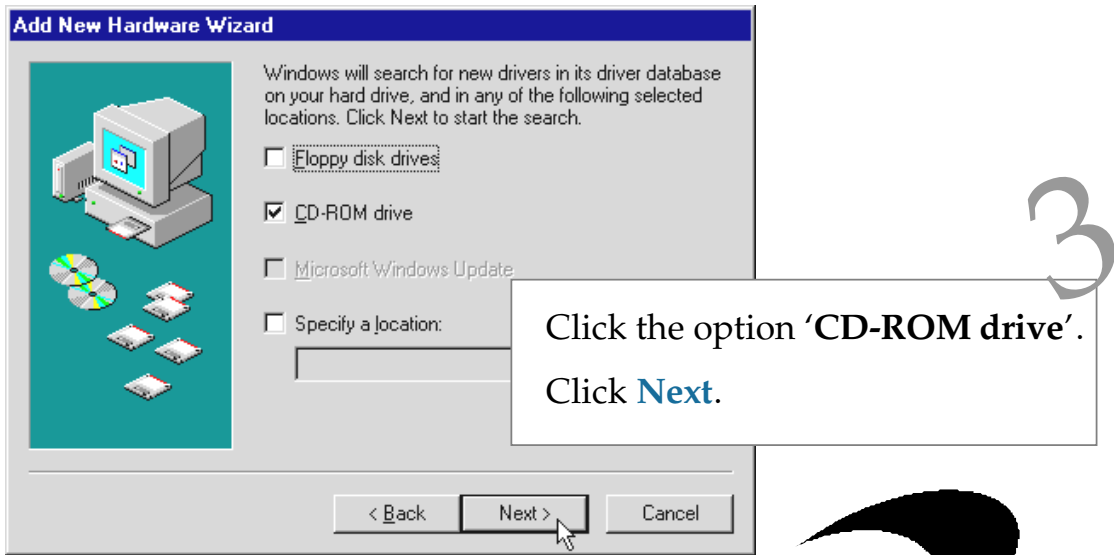

Windows will prompt that it has located the driver.

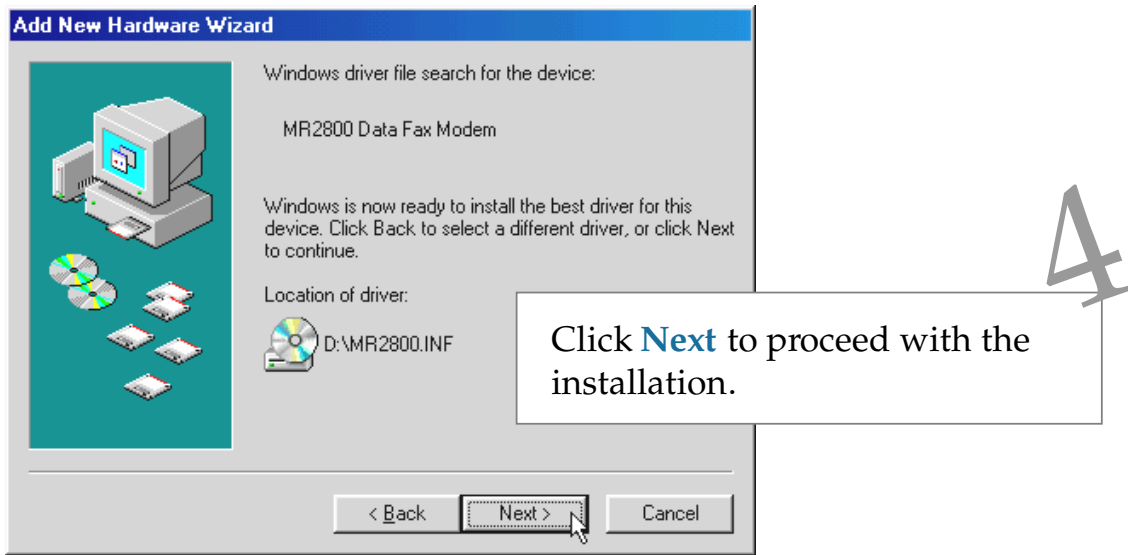

Upon completion, the following window will be displayed.

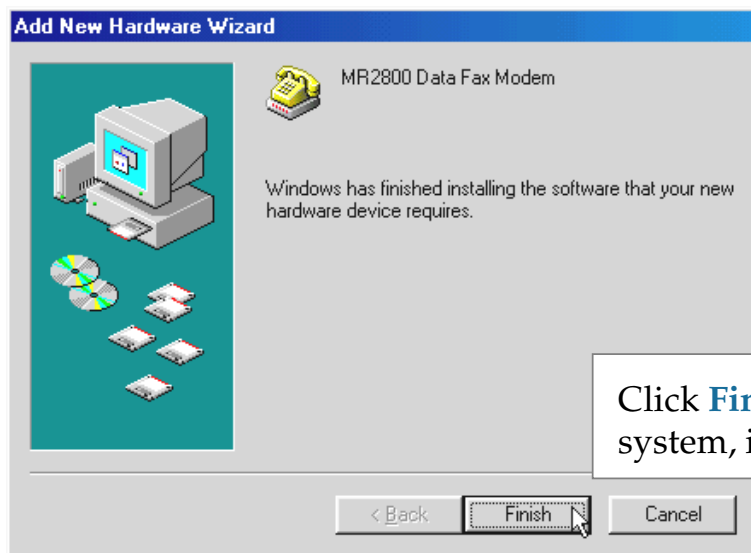

Click **Finish**. Restart your system, if prompted.

5

This completes the installation of the modem driver in Windows® 98. Proceed to the next chapter to test your modem.

Chapter 5

Testing the Modem Card

This chapter contains information on how to test your modem card in Windows® 95/98.



The screens illustrated may differ from what you see on your system, but the steps still apply.

5.1 Windows® 95/98

From the Windows taskbar, click **Start > Settings > Control Panel**.

Double-click the **Modems** icon.

You will see the MR2800 modem listed.

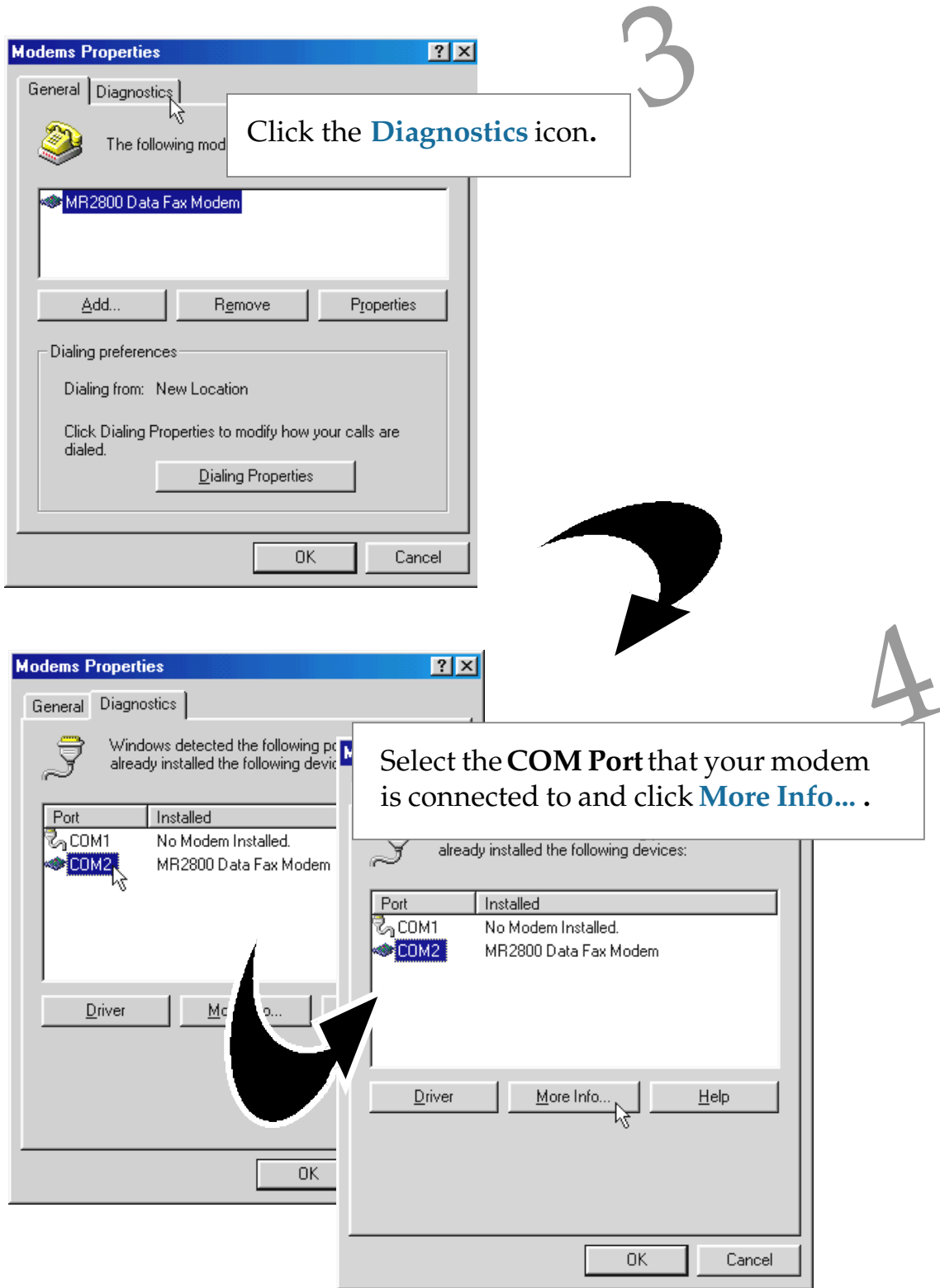

The **More Info...** window will appear, showing a list of AT commands. This indicates a successfully installed modem. Click **OK**.

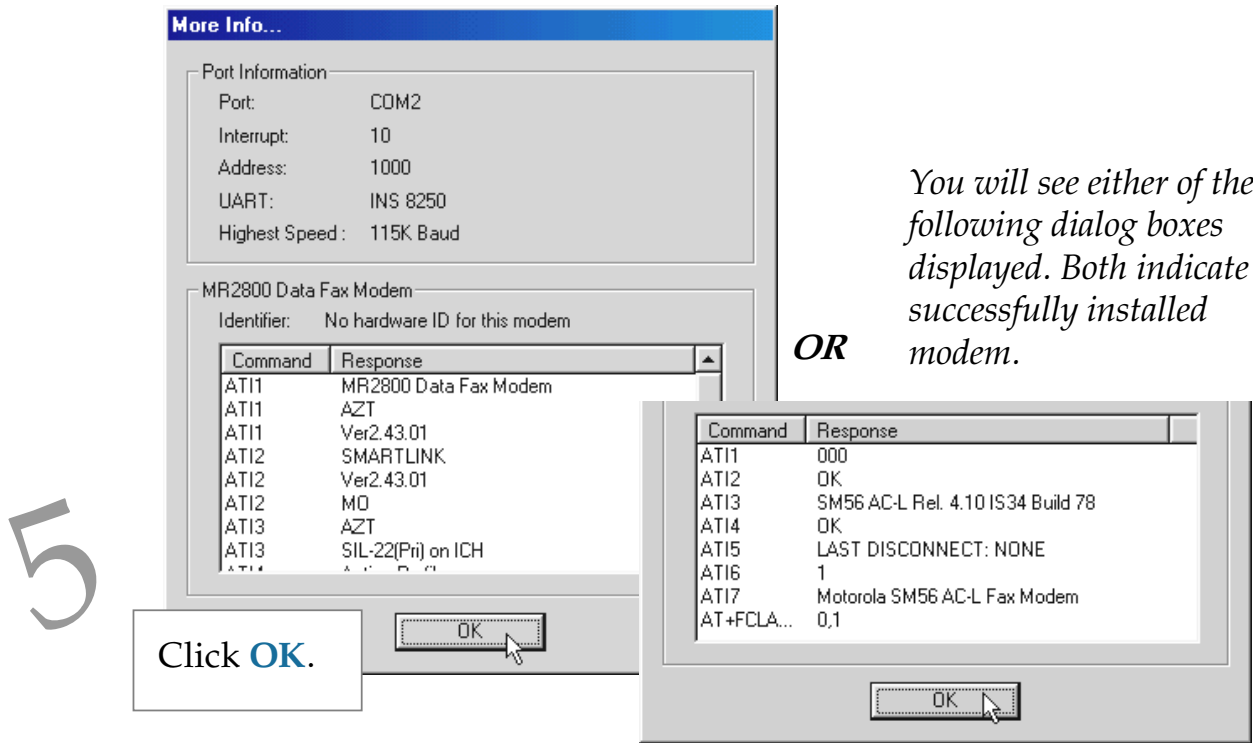

If your modem is not installed properly, the set of AT commands will not be listed. You may also be prompted by an error message, stating that it was unable to open the COM Port. If this happens, refer to the **Appendix A - Frequently Asked Questions** “While testing the modem, the system gave an error message stating that it was unable to open the COM Port.”

Frequently Asked Questions

You may encounter some problems or doubts while installing or using your modem. This chapter highlights some of the more common issues concerning your modem and their possible solutions.



What is V.90 ?



V.90 is a new standard approved by the International Telecommunication Union for "56K" analog modems. It is a compromise officially reached between the two competing standards - X2 (from 3COM/USR) and K56Flex (from Rockwell/Lucent).



How do I identify the Modem Riser card and its driver ?



The Modem Riser card has its model name printed on the serial number label located at the rear of the card.

Alternatively, you can issue an AT13 command using any Telephony Data Terminal application to get the driver version.



This modem is set to V.90. But why am I getting slow connections to my ISP ?



Majority of the telephone lines and ISP are already supporting V.90 connections. However, like all data connection, the connection is sensitive to the amount of noise present in the phone line. Hence, only very "clean" phone line can get high connection rate or throughput. You may want to check with your telephone provider.



How do I see the resources listings ?



1. From the Windows taskbar, click **Start** > **Settings** > **Control Panel**.
2. Double-click  icon.
Modems
3. Click the **Diagnostics** tab. Select your product model and click **More Info...** option.

The IRQ (Interrupt) and memory range (Address) used by the modem will be listed.



The modem hangs up when an incoming call is received.



Disable the Call Waiting function for the Online Service, Internet Connection and/or communications software you are using.



When I tried to dial out, the system gave me an error message “No Dial Tone”.



Check the Telephone Cable (PHONE) connection. If necessary, plug out the Telephone Cable and reconnect the cable.



There are incomprehensible characters appearing on the screen.



The data, parity and stop bit settings are incorrect. Try using the default values or check with your ISP.



Why does my modem always connect at 33.6Kbps and not 56Kbps or V90 ?



Check with your Internet Service Provider (ISP) to ensure that they support 56Kbps or V.90 connections. For modem with Country Selection feature, please ensure that the modem is set to your local country. To set the country select feature, see the following question.



I am using my system with the modem card in another country. Is there any settings that need to be changed ?



Yes. You need to ensure that the country setting for your modem card is correct for your location. Carry out the following steps:

1. Double-click  icon found at the corner of your taskbar.
2. From the window prompted, click the **Settings** tab.
3. Select your **current local country** and the appropriate **language** desired.
4. Click **OK**.



While testing the modem, the system gave an error message saying that it was unable to open the COM Port.



Make sure that you have closed all communication software (e.g. Hyperterminal, Dial-up Networking, etc.) when you are doing the diagnostics test.

However, if there is no communications software running, do the following:

1. From the Windows taskbar, click **Start** > **Settings** > **Control Panel**.
2. Double-click  icon.
System
3. Click the **Device Manager** tab.
4. Check whether there is any yellow exclamation mark on the modem device. If yes, remove the modem device and re-install the modem drivers.



How do I un-install the MR2800 driver installed in the system ?



1. From the Windows taskbar, click **Start** > **Settings** > **Control Panel**.

2. Double-click  icon.
Add/Remove Programs

3. Select "**Uninstall**" and click **Add/Remove**.

Follow the on-line instruction to complete the removal of the driver.



My system does not detect the modem when I boot up for the first time.



Check that:

1. *Your modem is fully inserted into the AMR Bus slot.*
2. *You have configured your card to either **Primary** or **Secondary** device **before** you install your card.*
3. *The jumper settings are correctly configured for the respective device.*

*(For details on the configuration, please refer to the section on “**Setting Up Your Modem Card**”.)*



I cannot find AC'97 Audio (or AC'97 Audio Controller) in my system BIOS.



If the feature is not found in your system BIOS, please check with your motherboard supplier for an updated system BIOS.

Appendix B

Technical Specifications

This chapter contains the technical specifications of your card. The information may be more useful for technically inclined users.

Modem Standards

- V.90, K56Flex 56Kbps
- V.34 (33.6Kbps), V.32bis, V.32, V.23, V.22bis, V.22, V.21
- Bell 212A, Bell 103

Modem Data Rates

- 56Kbps (download speed from Internet Service Provider)
- 33.6Kbps — 300bps

Data Throughput

- Up to 115.2Kbps (with compression)

Error Correction

- V.42 LAP-M and MNP2-4

Data Compression

- V.42bis and MNP5

Fax Modulations

- V.17, V.29, V.27ter, Fax Class 1, V21 channel 2 group 3 fax mode

- AMR 1.01 Compliant
- Auto dialing and auto answer
- Line quality monitoring and re-train
- Tone or pulse dialing
- Silicon DAA line interface
- Digital Line guard (optional)
- Handset exclusion (optional)
- External connectors
 - 1 x RJ11 Telephone socket for telephone line



The product specifications herein are subject to change without prior notifications.

Appendix C

Card Layout

